

A series of horizontal bars of varying lengths and shades of gray on the left side of the page, with a line extending from the longest bar to a dot before the section header.

• VIDEO PORTIERS

CDC-2FxB

User manual: page 03
Manuel utilisateur: page 17



■ Introduction

You have just acquired a video door entry system door station CDC-2F1B or CDC-2F2B and we thank you.

This door station is on Digital 2 wires bus technology and has been design to provide you a great confort of use :

- Feedback for disable people
- Vandal resistente
- IP rating 64
- Two relay per door station
- Upto 4 door stations and 32 monitors.

It's robust and waterproof conception will provide you a long term use and satisfaction for your day to day life.

PROEM team

Digital bus
2 wires
4 cameras
32 monitors

Vous venez de faire l'acquisition d'une caméra de vidéo-portier CDC-2F1B or CDC-2F2B et nous vous en remercions.

Cette caméra couleurs 2 fils bus digital a été conçue pour vous offrir un grand confort d'utilisation :

- *Signalisation pour personnes handicapées*
- *Haute résistance au vandalisme*
- *Indice de protection IP 64*
- *Deux relais par caméra*
- *Jusqu'à 4 caméras et 32 moniteurs*

Sa robustesse et son excellente étanchéité vous assureront une longévité d'utilisation et nous espérons qu'elle vous apportera entière satisfaction et saura répondre aux attentes de votre quotidien.

L'Equipe PROEM

1. Parts and Functions

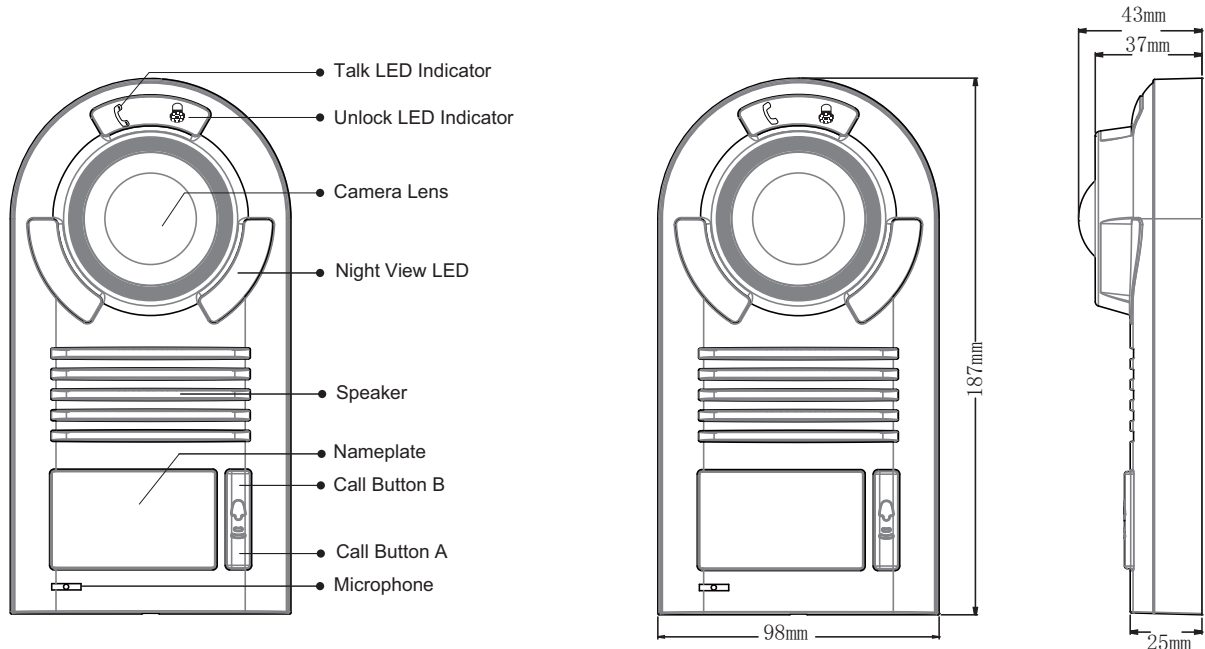

2. Terminal Descriptions

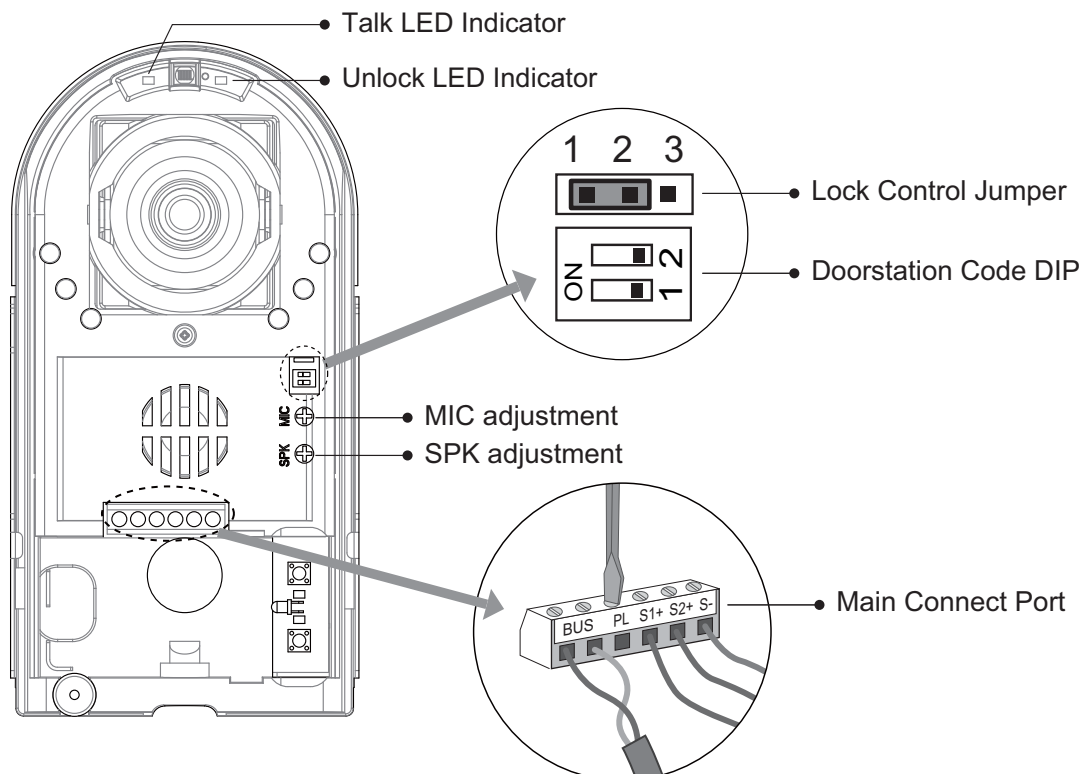

CDC-2FxB

English

- **Talk LED Indicator:** During talking, the LED will be turned on. After finishing talking, it will be turned off.
- **Unlock LED Indicator:** When release the first lock, it will be flashed one time. When release the second lock, it will be flashed two times.
- **Lock Control Jumper:** To select the lock type: see 5.2.1, 5.2.2
- **Doorstation Code DIP:** Total 4 doorstations can be supported, see 6.1
- **Main Connect Port:** To connect the bus line and the electronic locks.
- **BUS:** Connect to the bus line, no polarity.
- **PL:** External lock power input, connect to the power positive (power +).
- **S1+, S2+:** Lock power(+) output, to connect 2 locks.
- **S-:** Lock power(-) output, connect to the power(-) input of locks (only when using the camera to power the locks, if using the external power supply for the locks, the S- will not be connected).

■ 3. Specifications

Lock Power supply:	12Vdc, 300mA (Internal Power)
Power Consumption:	1W in standby, 12W in working
NO, COM dry contact:	Max. 48V dc 1.5A
Unlocking time:	1 to 9 seconds, set by Monitor
Working temperature:	-10°C ~ 45°C

■ 4. Mounting and Settings

4.1 How to open the unit

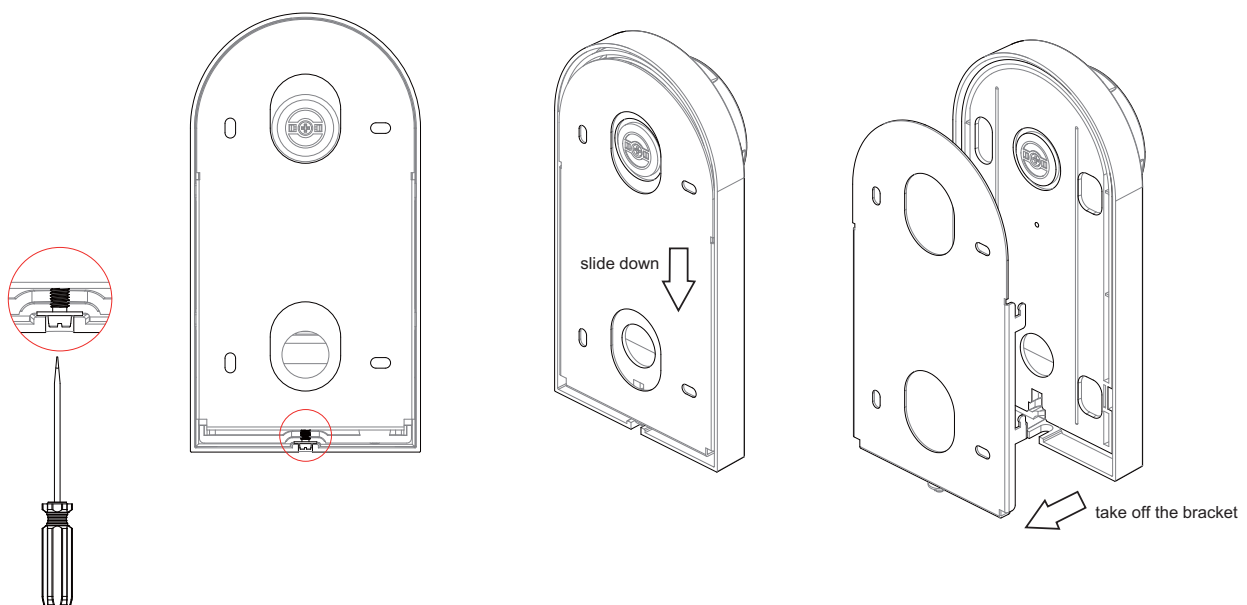

4.2 Door station Mounting

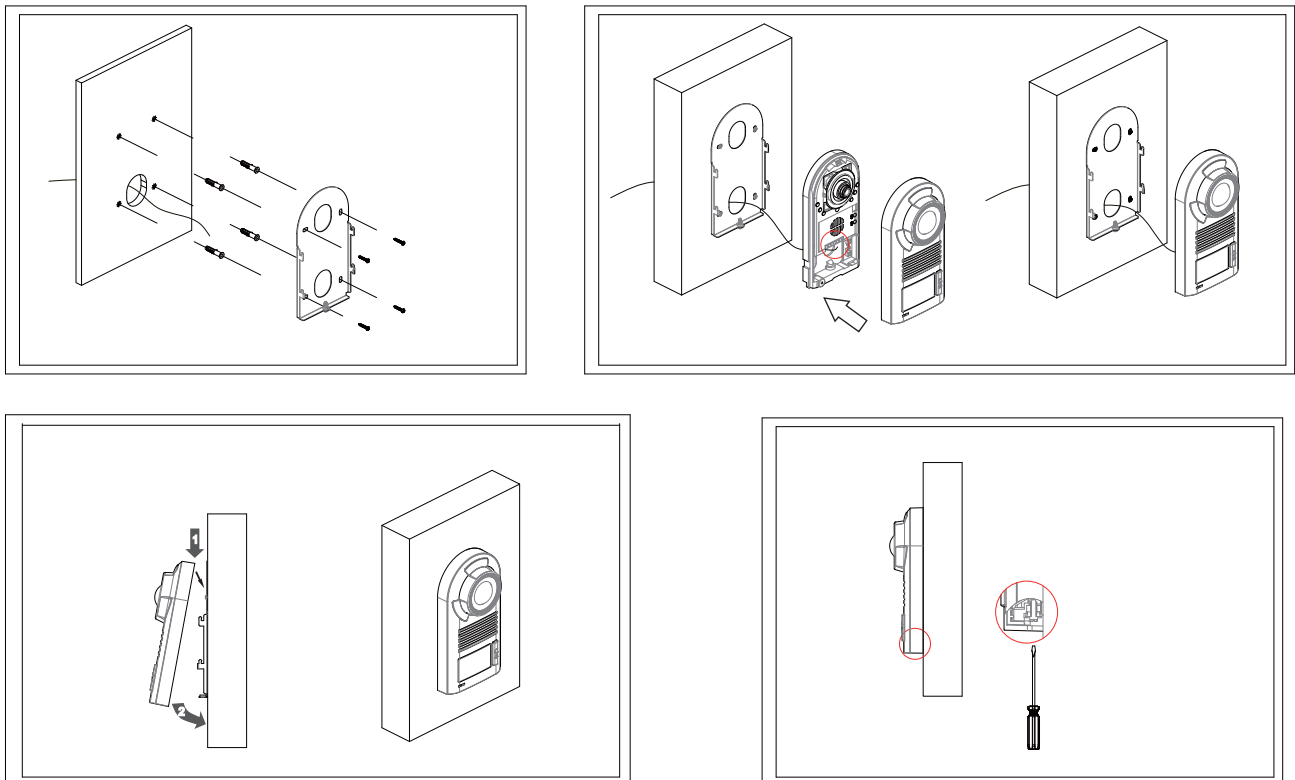

4.3 Button Mode Setting

You can set either single button mode or double button mode on door station .

- **Single Button Mode:** that means the door station only has one button, it can only call the monitor with its code among 00~15. please refer to 6.2.
- **Double Button Mode:** that means the door station has two buttons, A button can call the address 00~15 of the monitor, and B button can call the address 16~31 of the monitor. please refer to 6.2.

How to set the button mode

1. **Single Button Setting:** set the code of door station on 10 (refer to 6.1), press the two buttons at the same time, and then power on for 3s, the unit will ring "bi...", that means single button is performed.
2. **Double Button Setting:** set the code of door station on 01 (refer to 6.1), press the two buttons at the same time, and then power on for 3s, the unit will ring "bi...bi...", that means double button is performed.

Note: single button is default in restore setting.

4.4 Placing Name Label

Move the plastic cover away to open the transparent name label cover, insert a name paper, then put the plastic cover back to the panel.

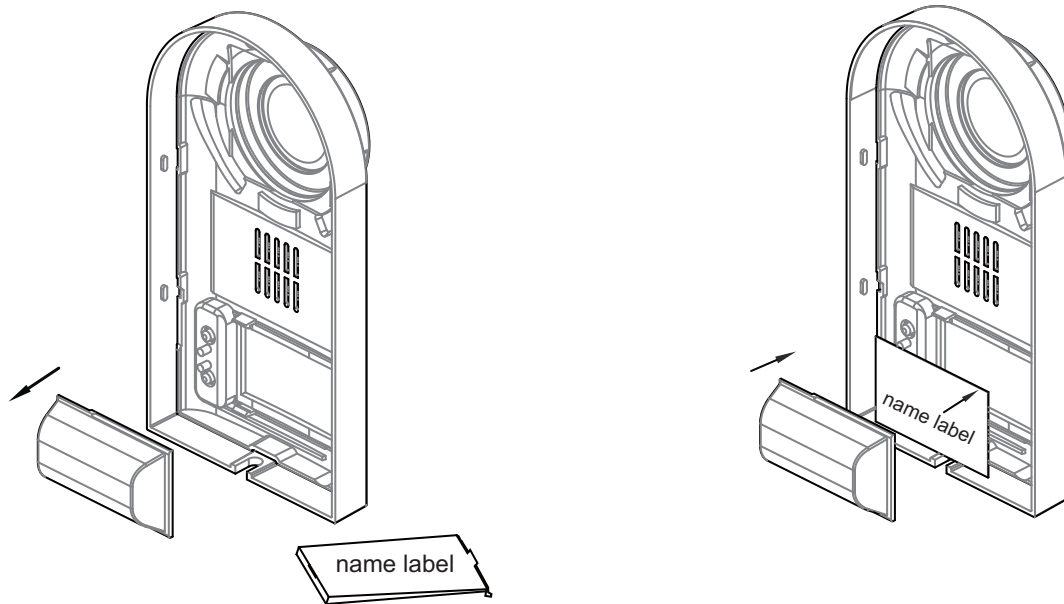

4.5 Adjusting Camera Angle

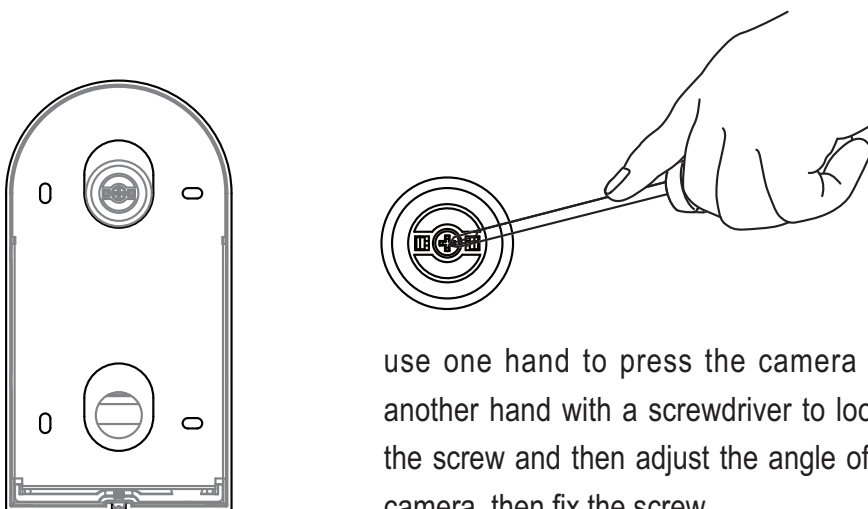

use one hand to press the camera and another hand with a screwdriver to loosen the screw and then adjust the angle of the camera ,then fix the screw.

5 . Wiring and Connections

5.1 Basic Connection

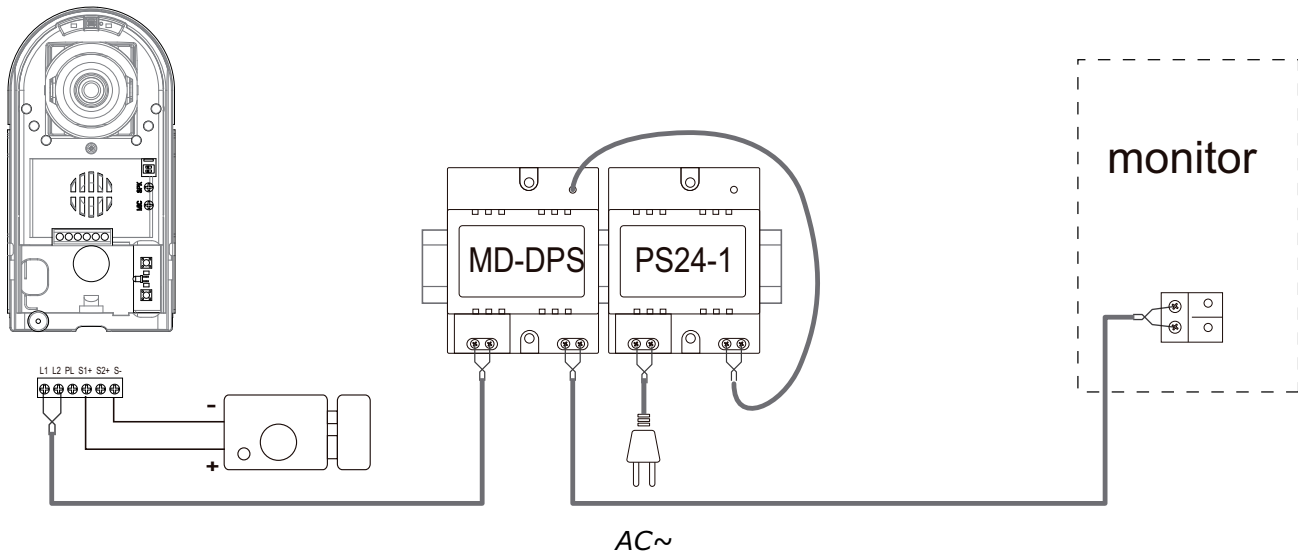

5.2 Electric Lock Connection

Door Lock Controlled with Internal Power

Note:

1. Electronic lock of Power-on-to-unlock type should be used.
2. The door lock is limited to 12V, and holding current must be less than 250mA.
3. The door lock control is not timed from Exit Button(EB).
4. The **Unlock Mode** Parameter of Monitor must be set to 0 (by default).

1 2 3



Connect one lock

Jumper position in 1-2

1 2 3



Connect two locks

Jumper position in 1-2

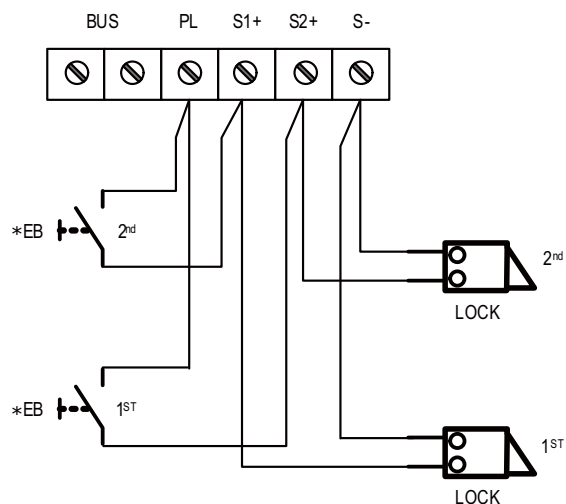
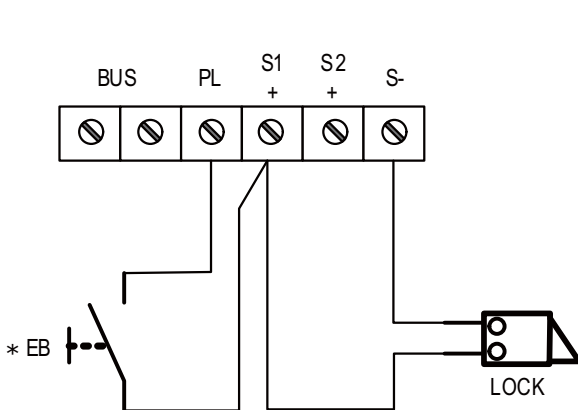

5.3 Electromagnetic Lock Connection

Door Lock Controlled with Internal Power

Note:

1. Electromagnetic lock of Power-off-to-unlock type should be used.
2. The door lock is limited to 12V, and holding current must be less than 250mA.
3. The door lock control is not timed from Exit Button(EB).
4. The **Unlock Mode** Parameter of Monitor must be set to 1 (by default).

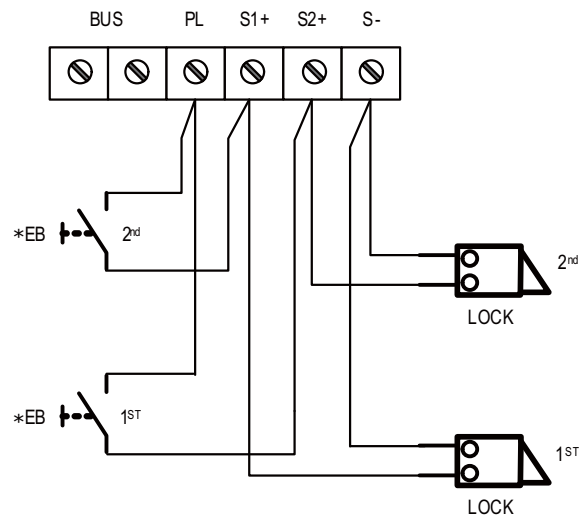
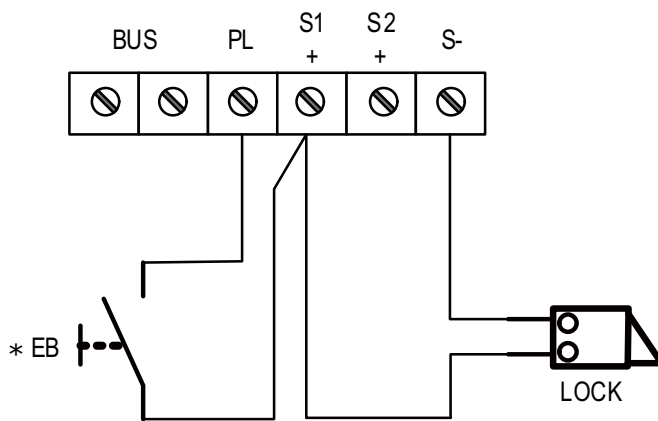
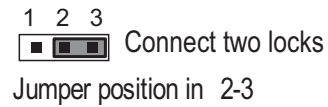
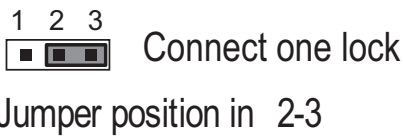

5.4 Door Lock Controlled with Dry Contact

Note:

1. The external power supply must be used according to the lock.
2. The inside relay contact is restricted to AC or DC 24V/3A.
3. The jumper must be taken off before connecting.
4. Setup the **Unlock Mode** of Monitor for different lock types.
 - Power-on-to-unlock type:Unlock Mode=0 (by default)
 - Power-off-to-unlock type:Unlock Mode=1

connect one lock

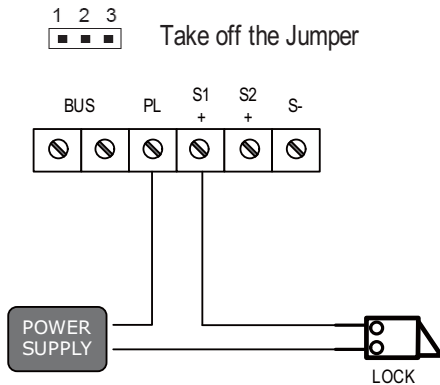

connect two locks

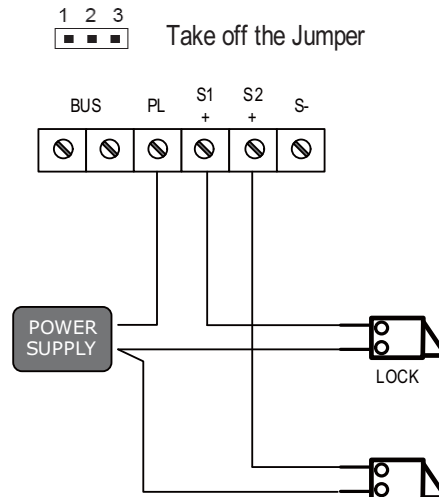

5.5 How to setup the unlock parameter in Monitor

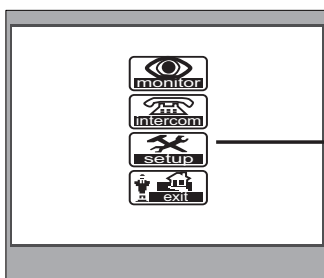

1. Press MENU button twice to enter the MAIN MENU page, then press setup item.

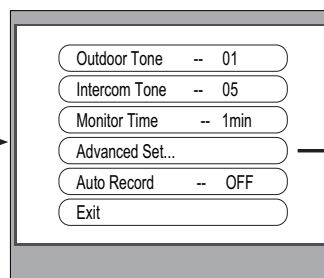

2. Select Advanced Set... item and press MENU button to enter, a password will be asked.

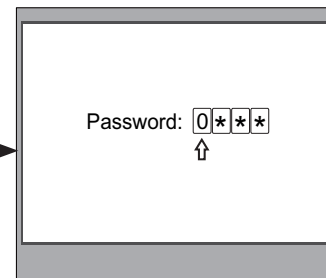

3. The default password is 2008. press ▲ / ▼ button to change the value, Press ◀ / ▶ button to select the location, after finishing, press MENU button to enter next step.

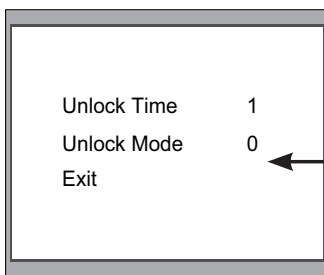

6. Use ▲ / ▼ to select the item, use ◀ / ▶ to change the value of the item. select Exit item, press MENU button to save the settings automatically.

Note:

1. must connect DT599 correctly before setting.
2. the parameter will be saved in DT599 automatically, so you need only set on one monitor.

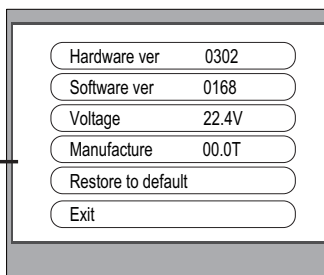

5. Press UNLOCK button and hold for 2s.

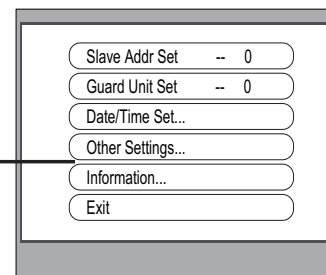

4. Select Information... item and press MENU button to enter next page.

5.6 Multi Doorstations Connection

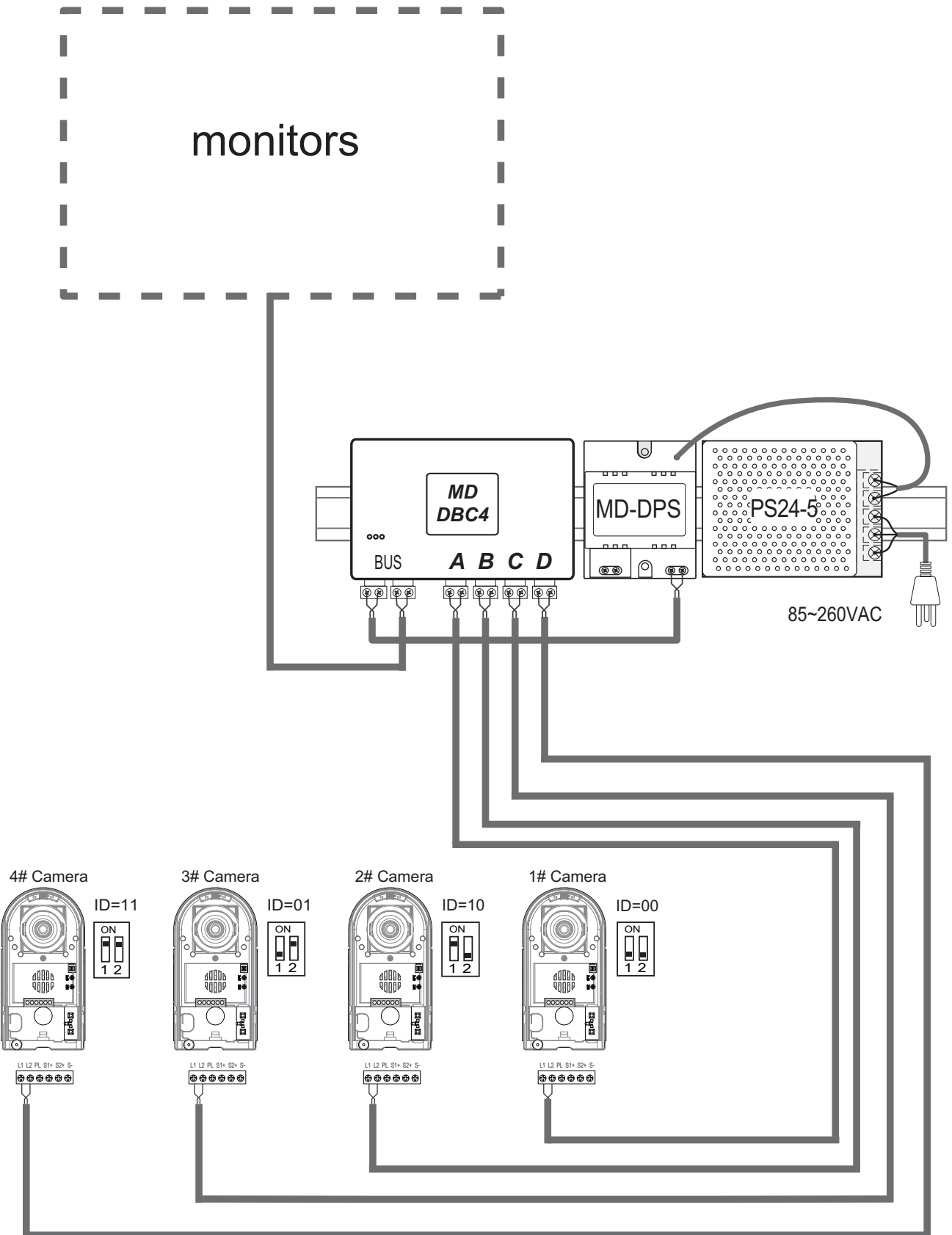

5.7 Multi Monitors Connection

5.7.1 Basic IN-OUT Wiring Mode

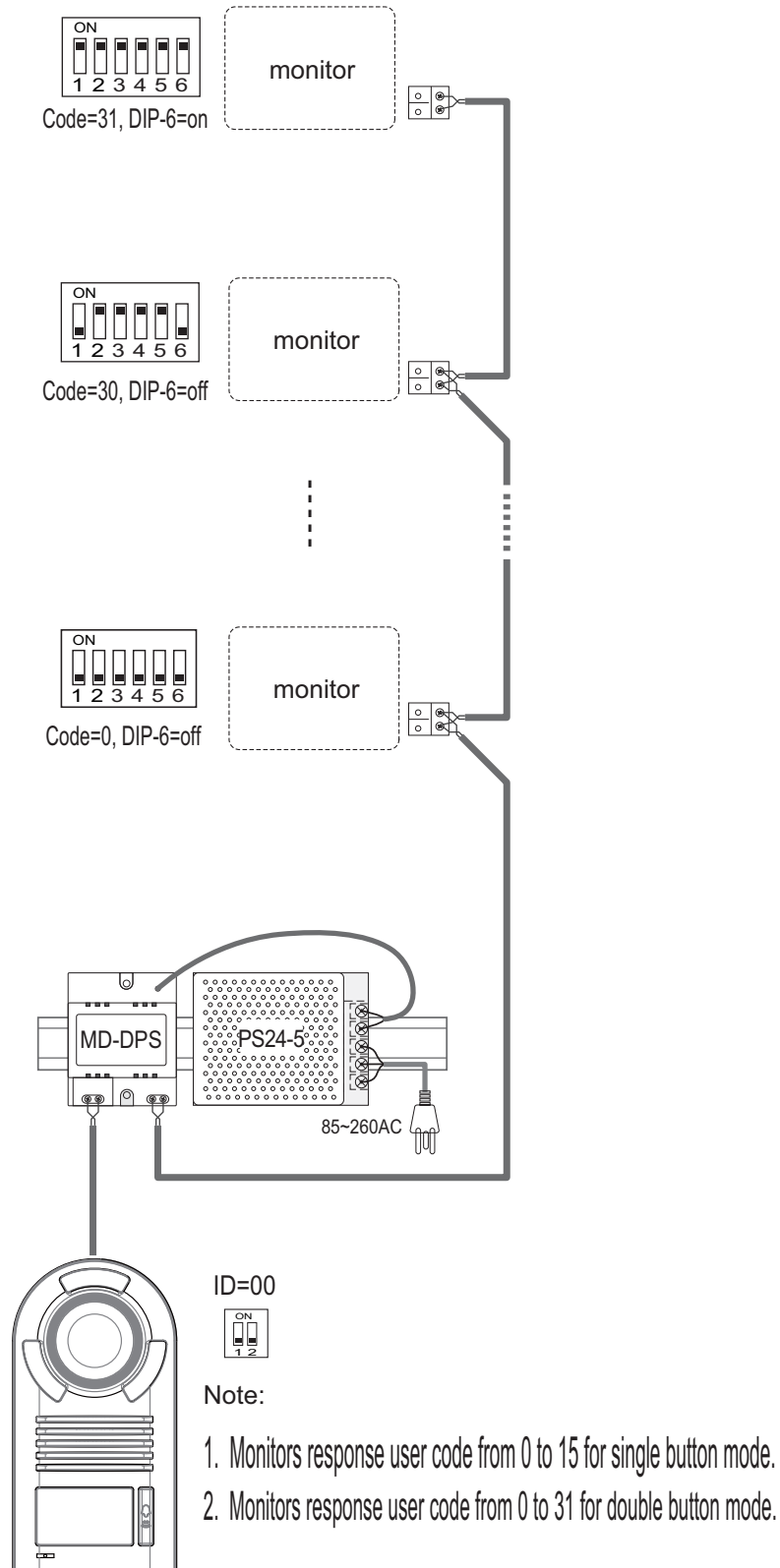

5.7.2 With DBC-4 Wiring Mode

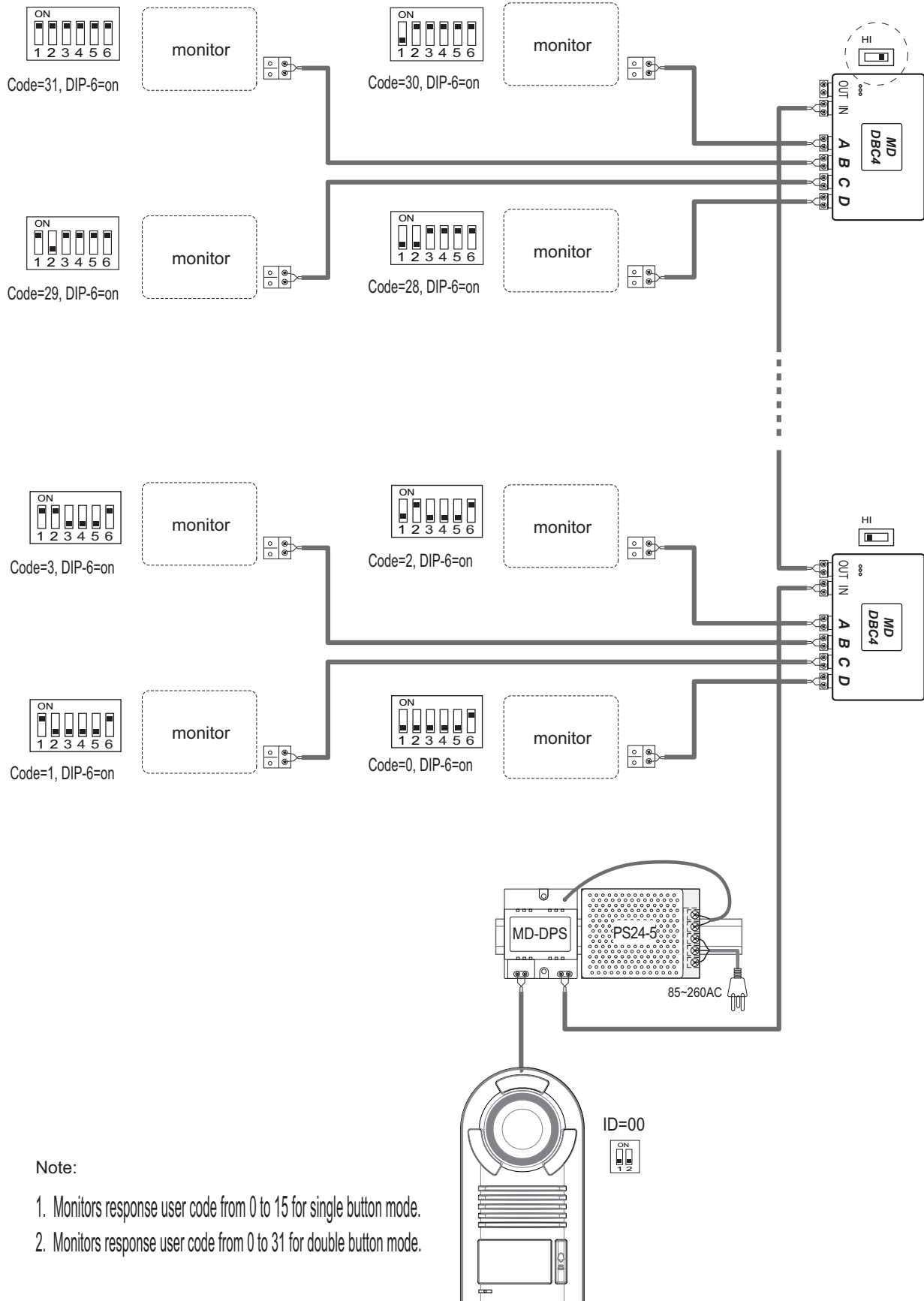

Note:



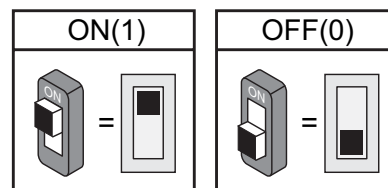

1. Monitors response user code from 0 to 15 for single button mode.
2. Monitors response user code from 0 to 31 for double button mode.

■ 6 . Setup



6.1 DIP Switches Settings of Doorstation



Total 2 bits on the DIP switches can be configured. The switches can be modified either before or after installation.

Bit state	Descriptions
	Default setting, ID = 0(00), set to the first Door Station.
	ID = 1(10), set to the second Door Station.
	ID = 2(01), set to the third Door Station.
	ID = 3(11), set to the fourth Door Station.

6.2 DIP Switches Settings of Monitor

There are 6 bit switches in total. The DIP switches are used to configure the User Code for each Monitor.













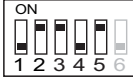







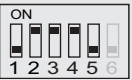

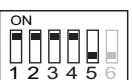



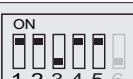



Bit-6 is line terminal switch, which have to be set to ON if the Monitor is in the end of the line(bus), otherwise set to OFF.

Bit state	Setting	Bit state	Setting
	The monitor is not at the end of the bus.		The monitor is at the end of the bus.

CDC-2FxB

English

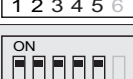
Bit-1 to Bit-5 are used to User Code setting. The value is from 0 to 31, which have 32 different codes .

Bit state	User Code	Bit state	User Code	Bit state	User Code
	Code=0		Code=11		Code=22
	Code=1		Code=12		Code=23
	Code=2		Code=13		Code=24
	Code=3		Code=14		Code=25
	Code=4		Code=15		Code=26
	Code=5		Code=16		Code=27
	Code=6		Code=17		Code=28
	Code=7		Code=18		Code=29
	Code=8		Code=19		Code=30
	Code=9		Code=20		Code=31
	Code=10		Code=21		

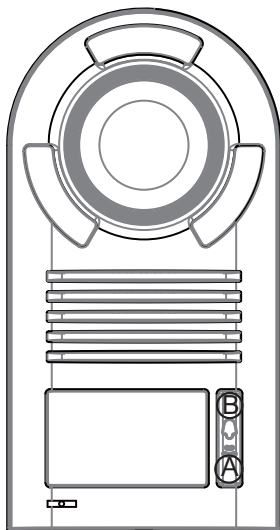

Note:

1. If the button mode is set to single button mode for door station,monitors response user code from 0 to 15.
2. If the button mode is set to double button for door station,monitors response button A must set the user code from 0 to 15.and button B set the user code from 16 to 31.

6.3 Notices

Name	Discription	Usage
PS24-5	Power supply,85~260Vac input,24Vdc/5A output,10 DIN modules	Connect with multi doorstations or multi monitors(up to 2 or above)
PS24-1	Power supply,85~260Vac input,24Vdc/1A output,for basic kit only,4 DIN modules	Connect with one doorstation and one monitor.

7 . Cables requirements

The maximum distance of the wiring is limited in the DT system. Using different cables may also affect the maximum distance which the system can reach.

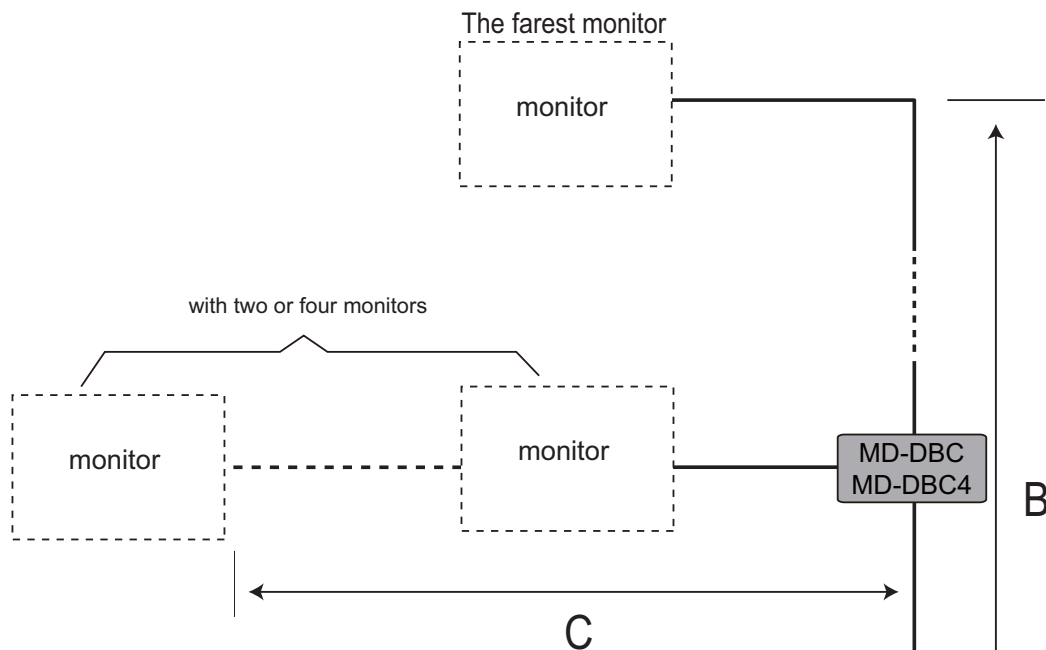

When Monitor quantity < 20

Cable Usage	A	B	C
Twisted cable 2x0.75 mm ²	60	60	30
Twisted cable 2x1 mm ²	80	80	40

When Monitor quantity > 20

Cable Usage	A	B	C
Twisted cable 2x1 mm ²	70	30	20
Twisted cable 2x1.5 mm ²	70	50	30

Note: If the monitor has been specified the distance, refer to the parameter.

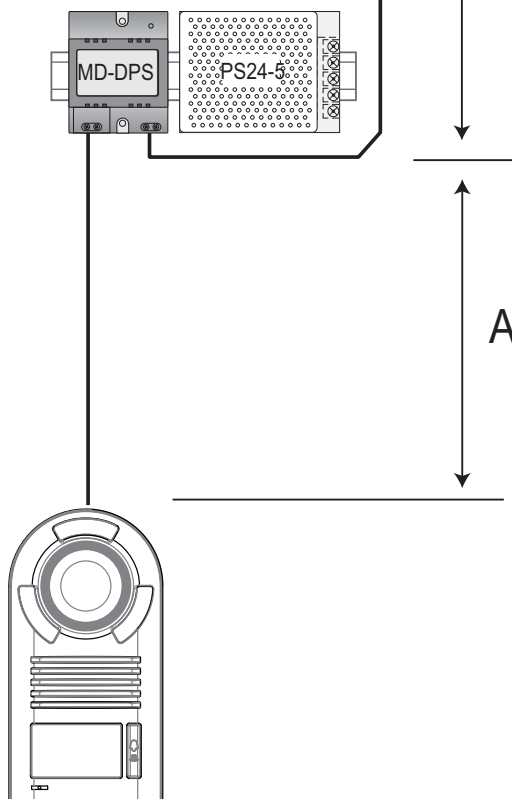

■ 1 . Composants et fonctions

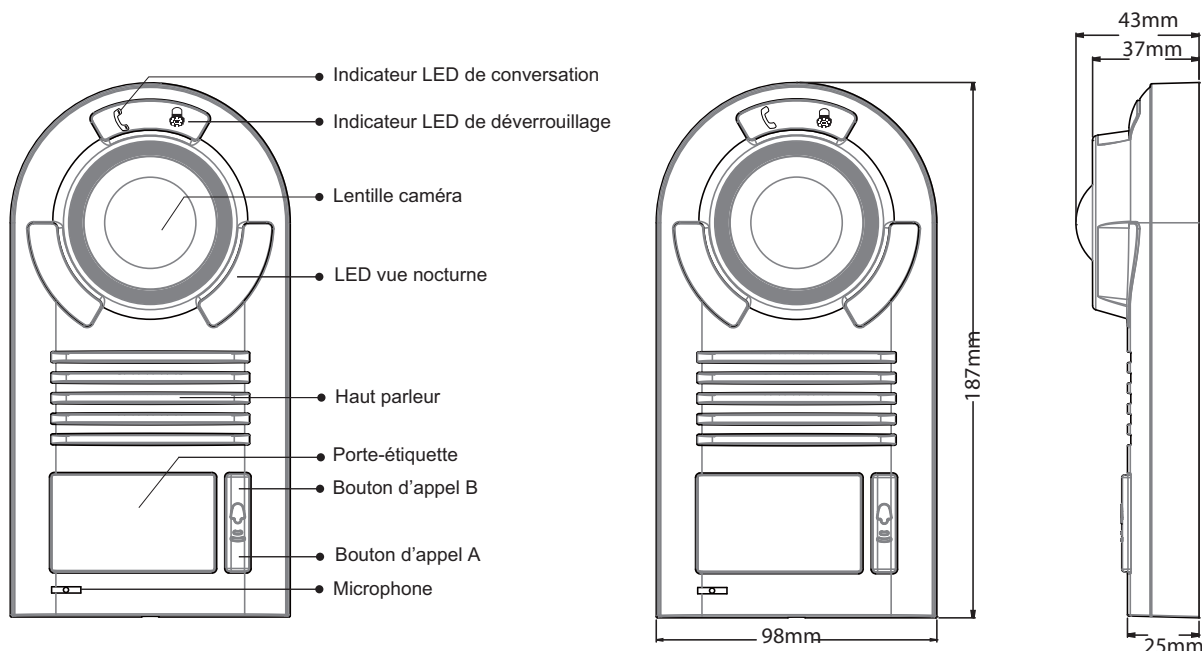

■ 2 . Description des borniers

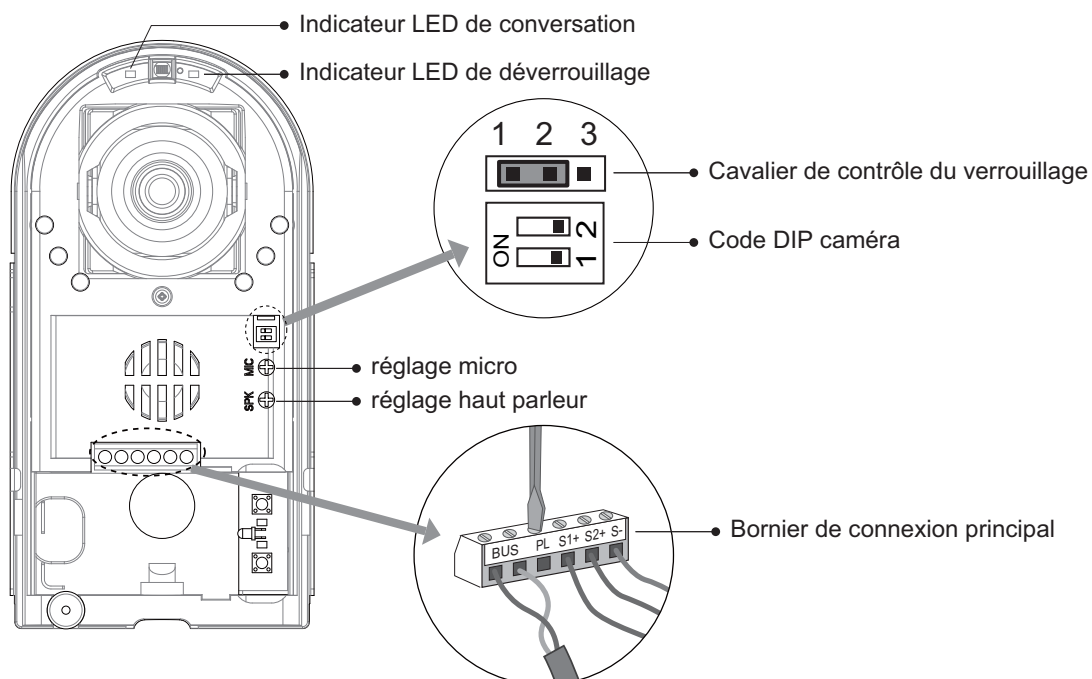

CDC-2FxB

Français

- Indicateur led de conversation: Durant la conversation, la LED s'éclaire et s'éteint à la fin de la conversation.
- Indicateur led de déverrouillage: Lors du déverrouillage de la première porte, la led s'éclaire une fois. Lors du déverrouillage de la seconde porte, la led s'éclaire deux fois.
- Cavalier de contrôle du verrouillage : Pour sélectionner le type de verrouillage, voir 5.2.1 , 5.2.2.
- Code DIP des caméras: 4 caméras au total peuvent être configurées, voir 6.1.
- Port de connexion principal: Pour connexion de la ligne bus et les gâches électriques.
- BUS: Connexion à la ligne bus, non polarisée.
- PL: Entrée d'alimentation de la gâche extérieure, connectée sur le +(power +).
- S1+, S2+: Sortie alimentation de la gâche (+), pour connecter 2 gâches.
- S-: Sortie alimentation de la gâche (-), pour connecter à l'entrée d'alimentation (-) des gâches (seulement lorsque la caméra alimente les gâches, si une alimentation externe alimente les gâches, le S- ne sera pas connecté).

■ 3 . Spécificités

Alimentation verrouillage :

12Vdc, 300mA(Alimentation interne)

Consommation :

1W en veille, 12W en fonctionnement

NO, COM contact sec:

Max. 48Vdc 1.5A

Temporisation de déverrouillage:

1 à 9 secondes, réglage sur le moniteur

Température de fonctionnement:

-10°C ~ 45°C

■ 4 . Montage et réglages

4.1 Ouverture de la caméra

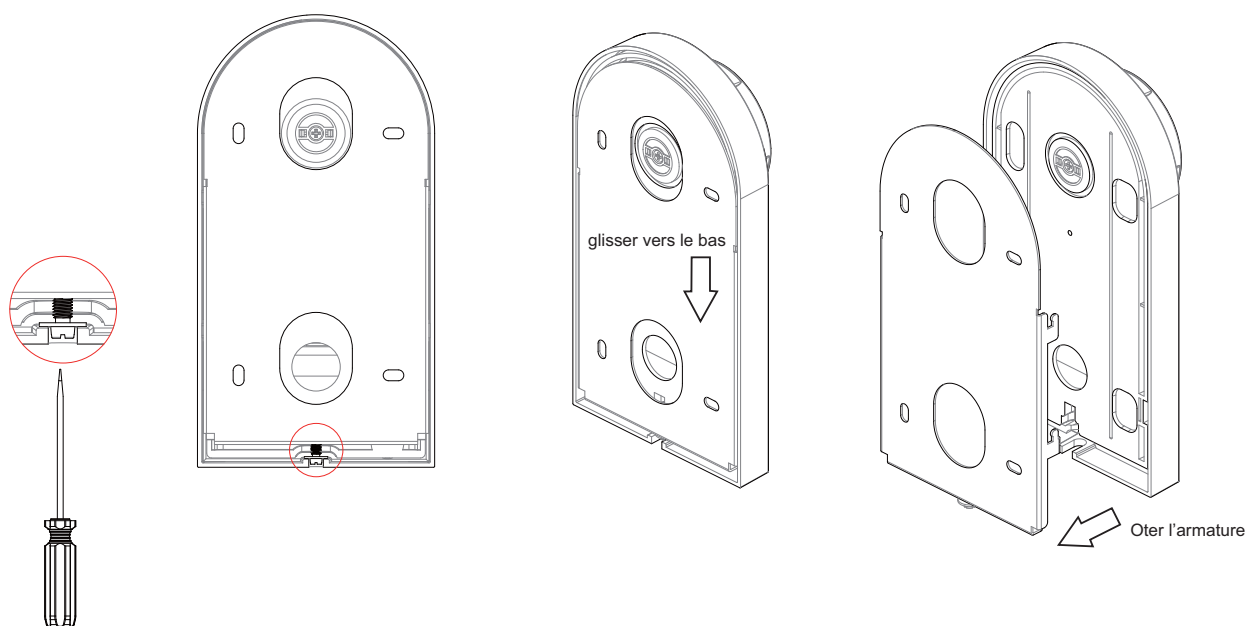

4.2 Montage de la caméra

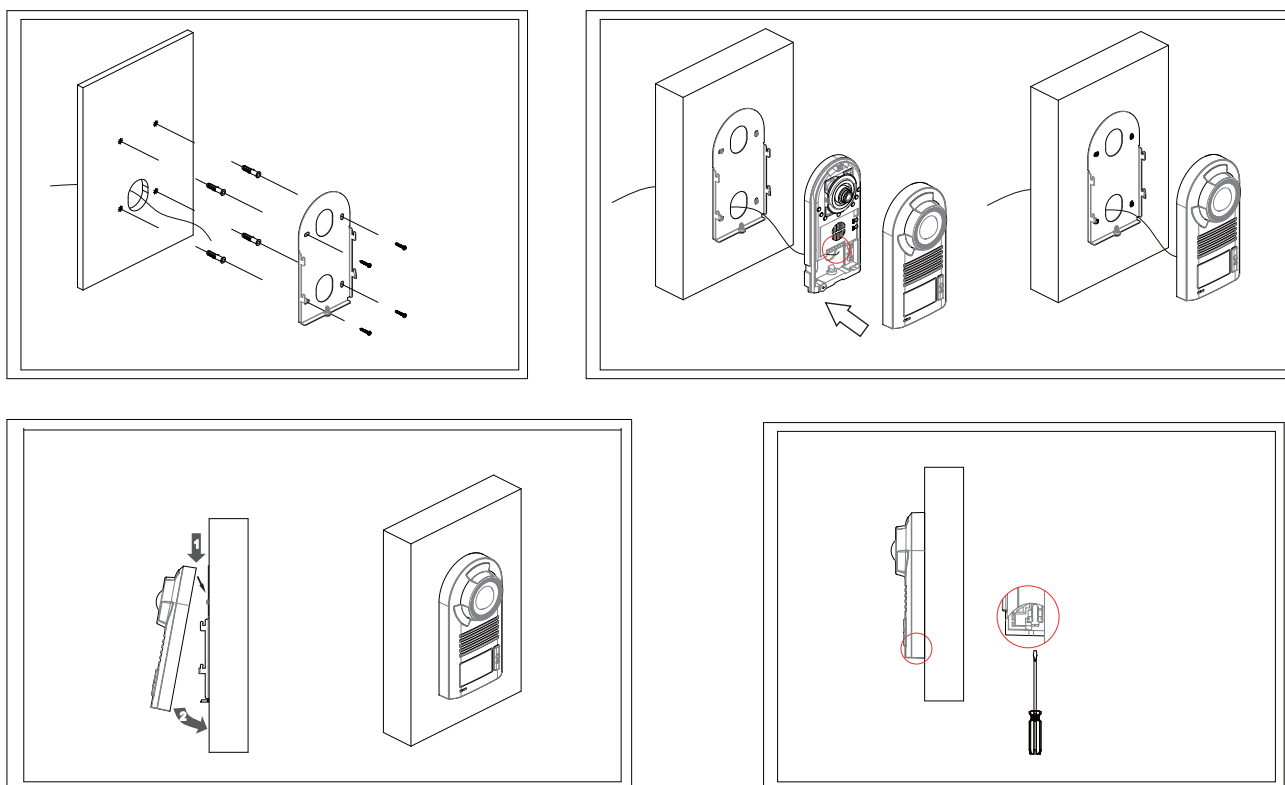

4.3 Réglage du nombre de boutons

La caméra peut être réglée en mode 1 bouton d'appel ou 2 boutons d'appel.

- **Mode 1 bouton d'appel:** la caméra est paramétrée avec 1 bouton d'appel et ne peut appeler que les moniteurs codés de 0 à 15 (voir 6.2).
- **Mode 2 boutons d'appel:** la caméra est paramétrée avec 2 boutons d'appel. Le bouton A appelle les moniteurs codés de 0 à 15, et le bouton B appelle les moniteurs codés de 16 à 31 (voir 6.2).

Comment effectuer le réglage

1. **Réglage mode 1 bouton d'appel:** réglez le code de la caméra sur 1.0 (voir 6.1), appuyez sur les 2 boutons simultanément, alimentez pendant 3 sec., la caméra émet un son "bip...", signifiant que le mode 1 bouton d'appel est activé.
2. **Réglage mode 2 boutons d'appel:** réglez le code de la caméra sur 0.1 (voir 6.1), appuyez sur les 2 boutons simultanément, alimentez pendant 3 sec., la caméra émet un son "bip...bip...", signifiant que le mode 2 boutons d'appel est activé.

Note : La caméra est réglée par défaut en mode 1 bouton d'appel.

4.4 Porte Etiquette

Otez le cache plastique et l'étiquette transparente, insérez l'étiquette papier, puis remplacez le cache sur la façade.

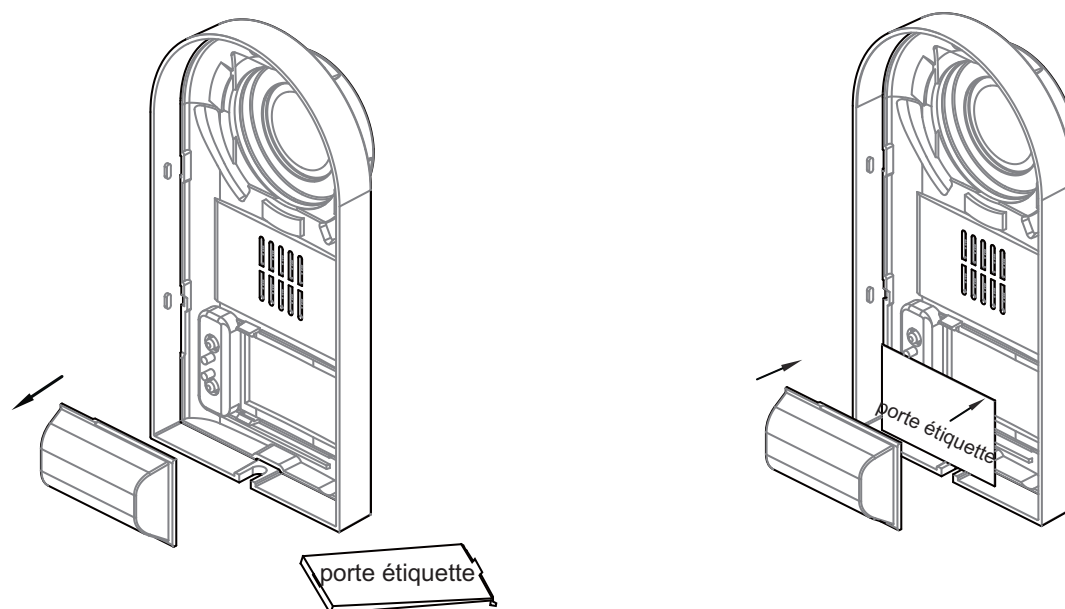

4.5 Réglage de l'angle de la caméra

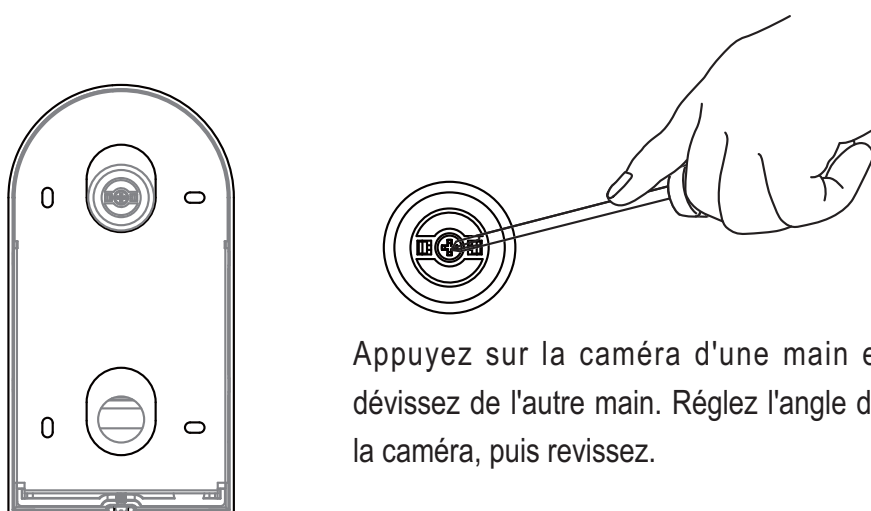

■ 5 . Câblage et connexions

5.1 Connexion de base

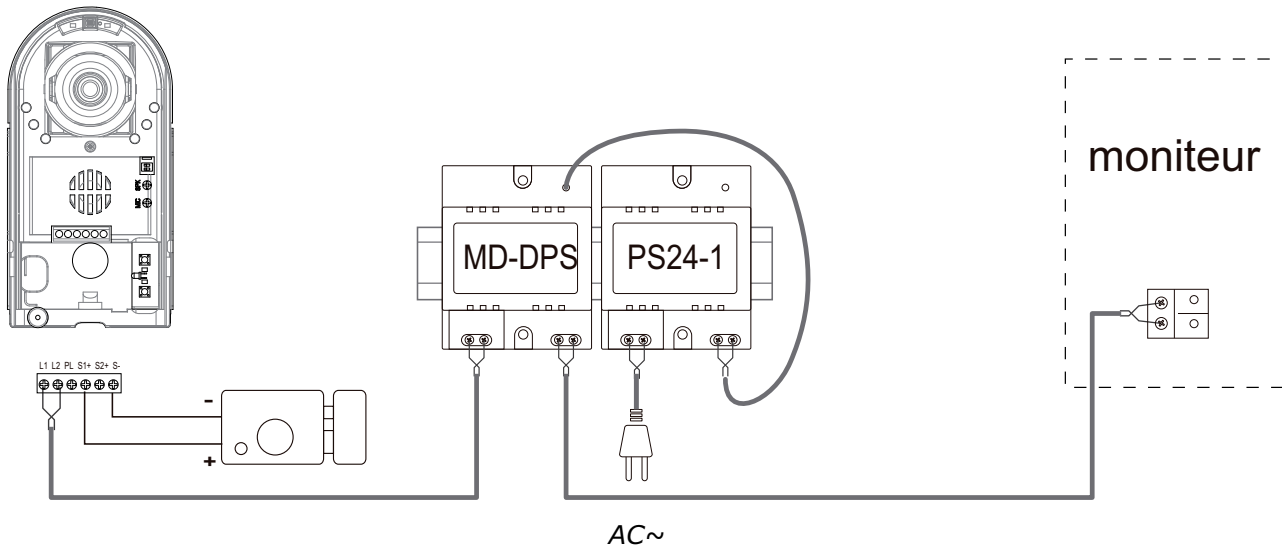

5.2 Connexion de la gâche électrique

Verrouillage avec alimentation interne

Note:

1. Une gâche électrique à émission doit être utilisée.
2. La gâche électrique doit être de type 12V, et consommer moins de 250mA.
3. Le contrôle du verrouillage n'est pas temporisé par le bouton de sortie (EB)
4. Le paramètre **Mode de déverrouillage** du moniteur doit être réglé sur 0 (par défaut).



Connexion 1 verrouillage

Cavalier en position 1-2



Connexion 2 verrouillages

Cavalier en position 1-2

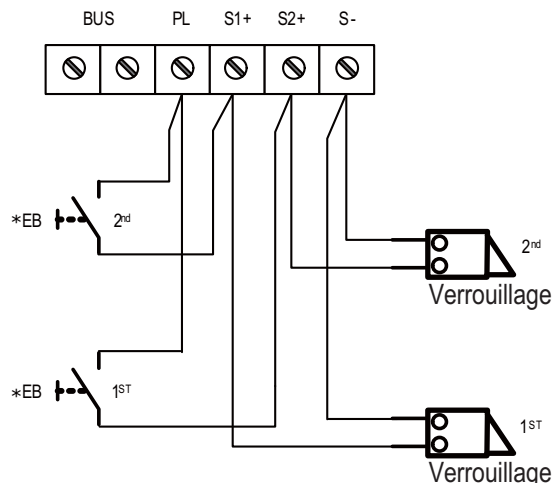
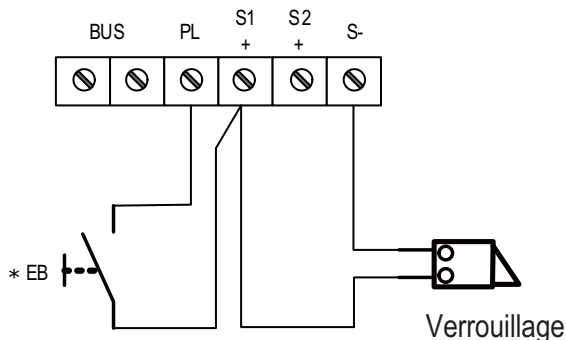



5.3 Connexion d'une ventouse électromagnétique

Verrouillage avec alimentation interne

Note:

1. Une ventouse magnétique à rupture doit être utilisée.
2. La ventouse doit être de type 12V, et consommer moins de 250mA.
3. Le contrôle du verrouillage n'est pas temporisé par le bouton de sortie (EB)
4. Le paramètre **Mode de déverrouillage** du moniteur doit être réglé sur 1 (par défaut).

1 2 3
 Connexion 2 verrouillages
 Cavalier en position 2 3

1 2 3
 Connexion 2 verrouillages
 Cavalier en position 2 3

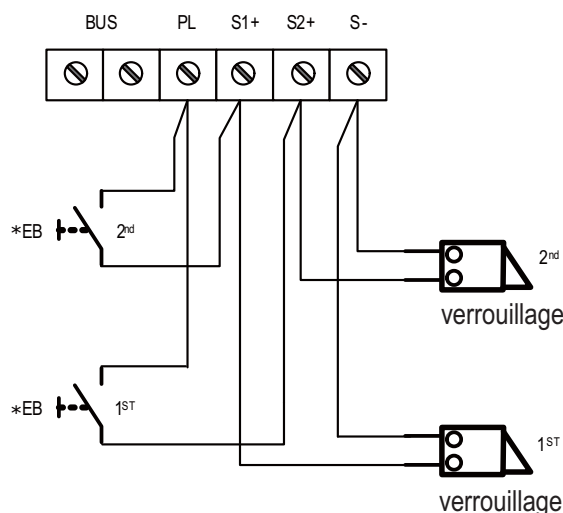
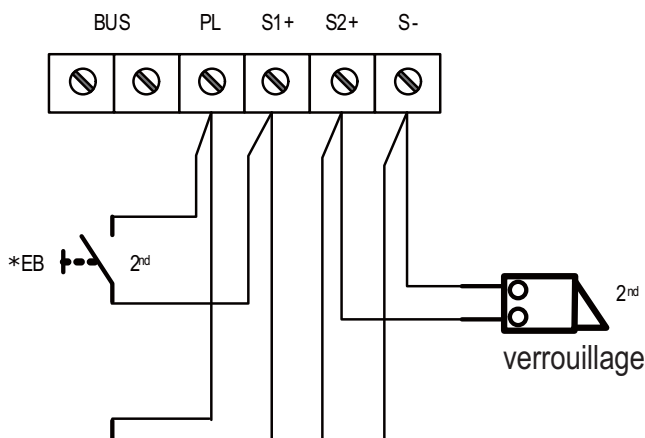

5.4 Verrouillage par contact sec

Note:

1. L'alimentation externe doit être adaptée au type de verrouillage.
2. Le contact interne est limité à 24 Vdc/Vdc et 3A.
3. Le cavalier doit être ôté avant la connexion.
4. Réglez le **Mode de déverrouillage** du moniteur selon les différents types de verrouillage.
 - Emission:Mode de déverrouillage=0 (par défaut)
 - Rupture:Mode de déverrouillage=1

Connexion d'1 verrouillage

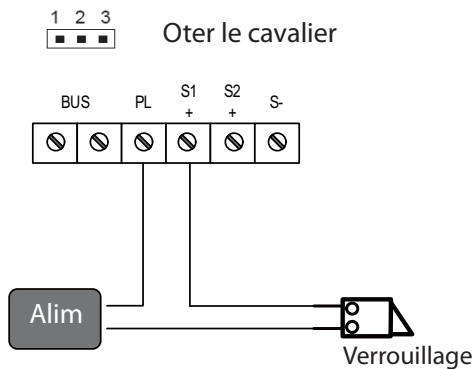

Connexion de 2 verrouillages

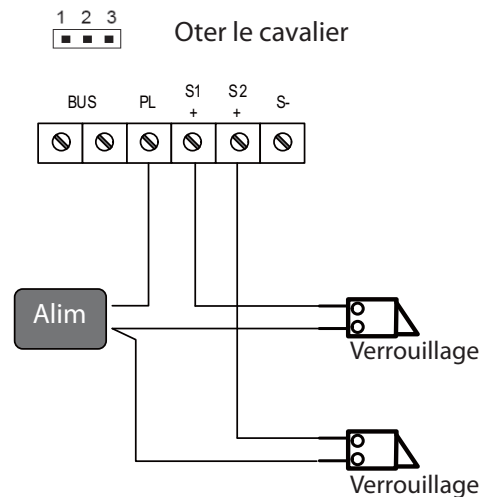

5.5 Réglage du paramètre de déverrouillage du moniteur

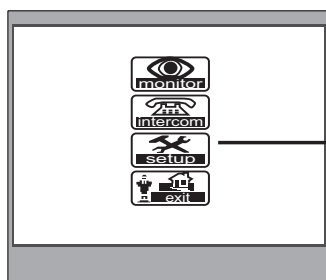

1. Appuyez sur le bouton MENU 2 fois pour entrer dans la page du menu principal, puis appuyez sur Réglage

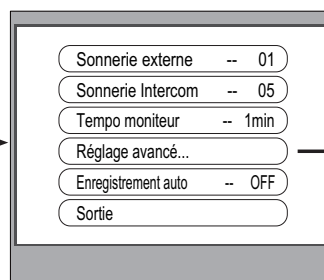

2. Sélectionnez Réglages avancés... et appuyez sur MENU pour entrer. Un mot de passe est demandé.

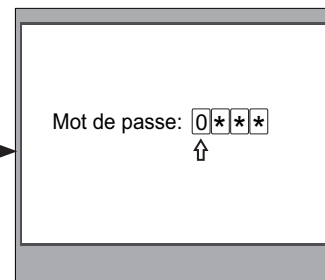

3. Le mot de passe par défaut est 2008. Appuyez sur ▲ / ▼ pour changer la valeur, appuyez sur ◀ / ▶ pour déplacer le curseur. Une fois la saisie terminée, appuyez sur MENU pour passer à l'étape suivante.

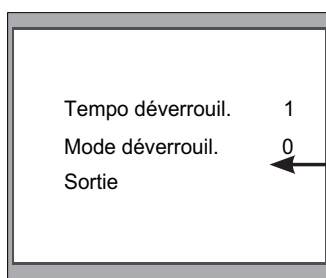

6. Utilisez ▲ / ▼ pour sélectionner le paramètre, utilisez ◀ / ▶ pour en changer sa valeur. Sélectionnez Sortir, appuyez sur MENU, pour enregistrer automatiquement les réglages.

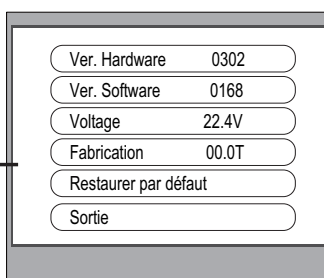

5. Appuyez sur le bouton de déverrouillage pendant 2 secondes.

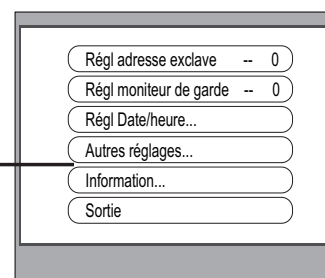

4. Sélectionnez la rubrique Information... et appuyez sur le bouton MENU pour passer à l'étape suivante.

Note: 1. La caméra doit être connectée avant d'effectuer les réglages.

2. Le paramètre sera enregistré dans la caméra automatiquement. Vous n'avez besoin de le régler que sur 1 moniteur

5.6 Connexion de plusieurs caméras

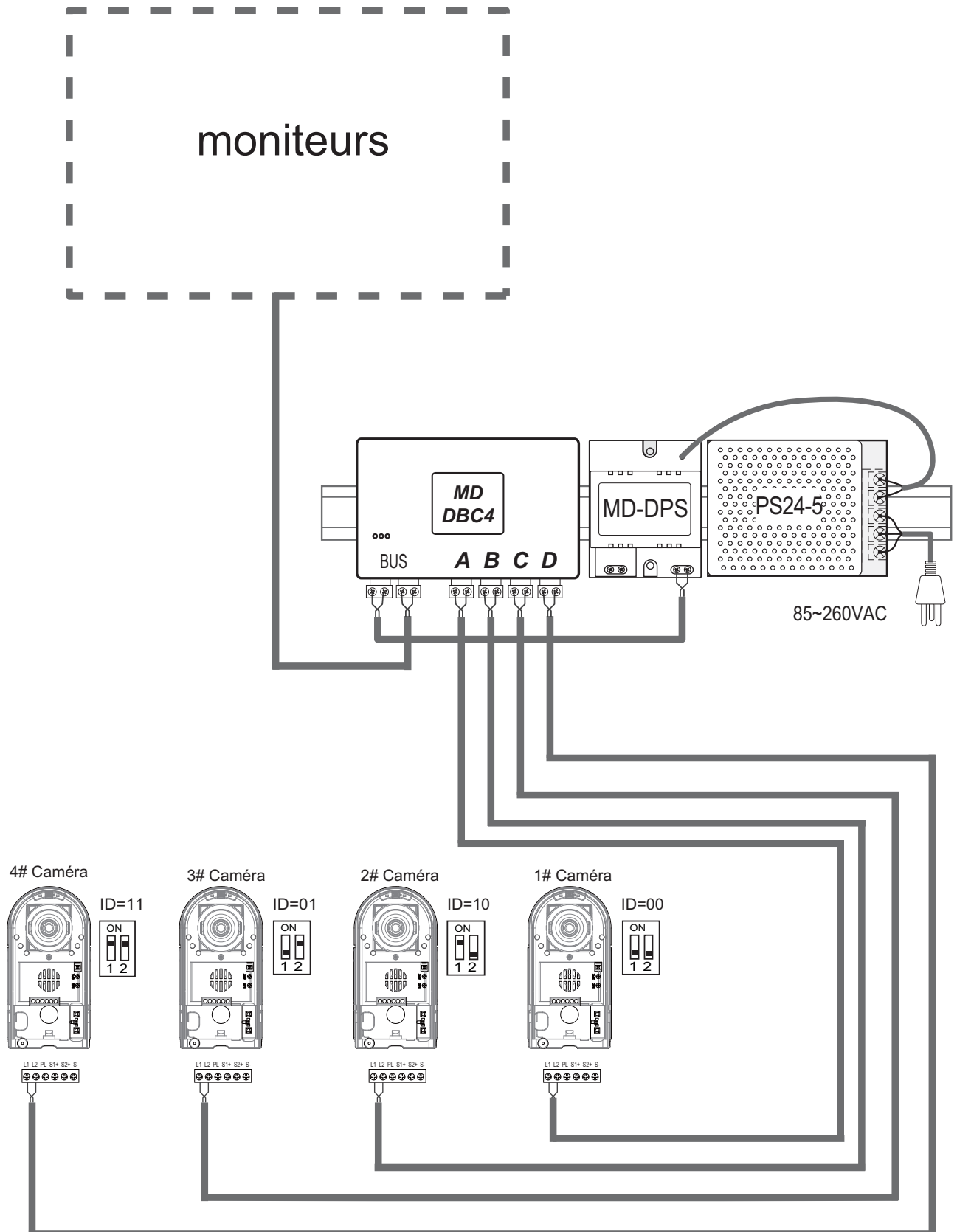

5.7 Connexion de plusieurs moniteurs

5.7.1 Câblage basique Entrée/Sortie

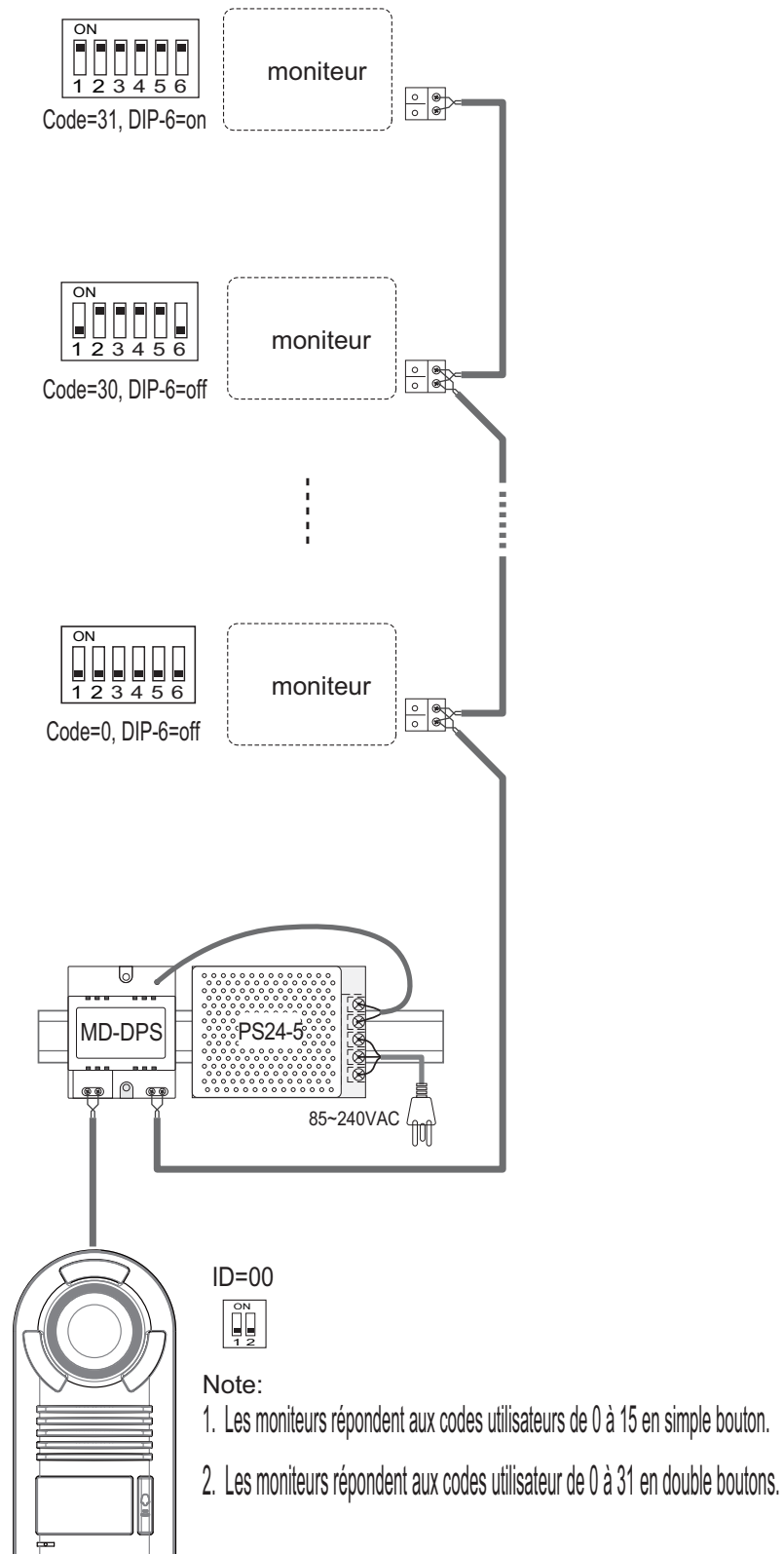

5.7.2 Câblage avec DBC-4

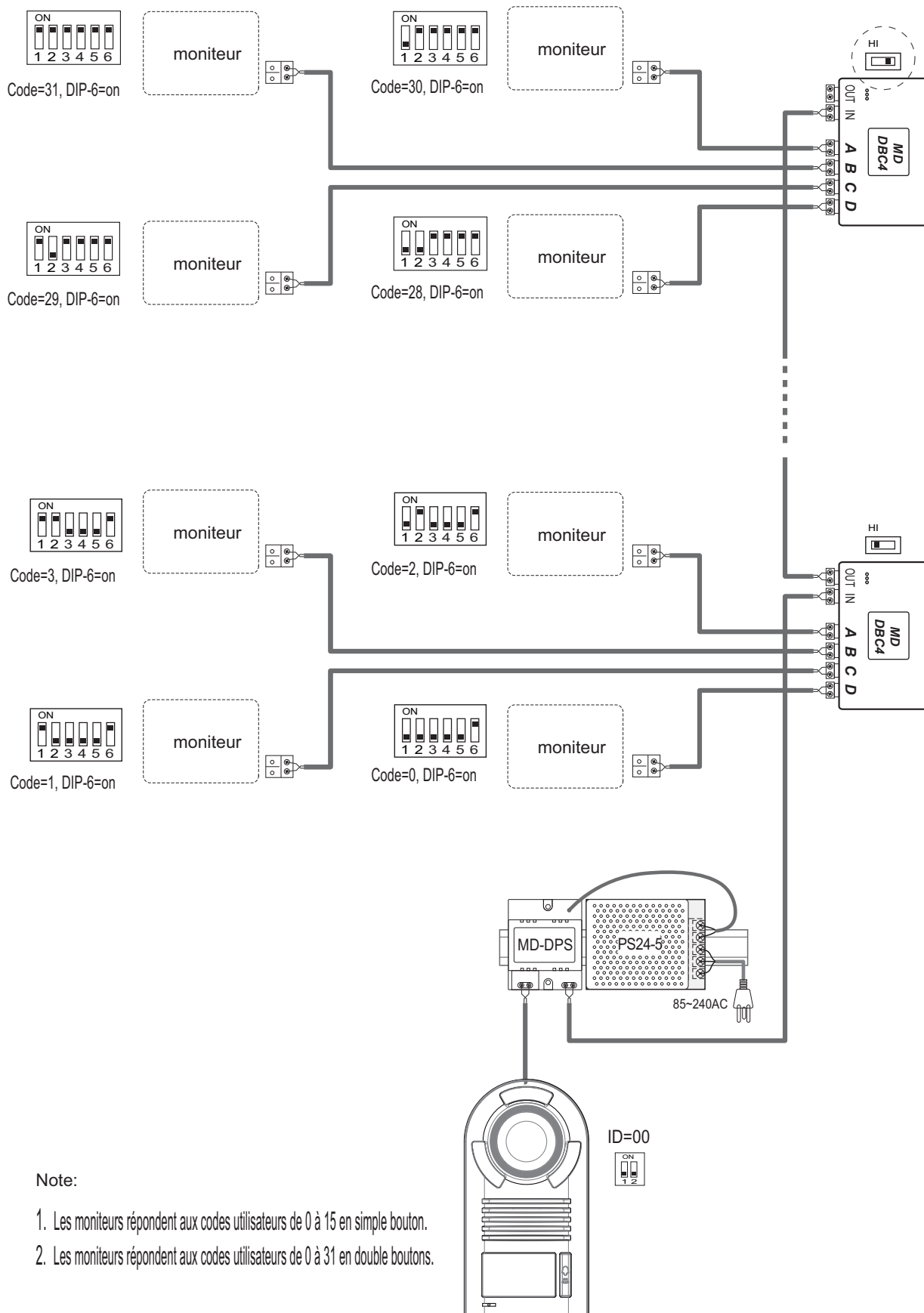

Note:



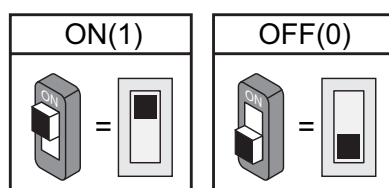

1. Les moniteurs répondent aux codes utilisateurs de 0 à 15 en simple bouton.
2. Les moniteurs répondent aux codes utilisateurs de 0 à 31 en double boutons.

■ 6 . Réglages



6.1 Réglages des dipswitches de la caméra



2 dips au total peuvent être configurés sur les dipswitches. Les switches peuvent être modifiés avant ou après l'installation.

Etât	Description
	Réglage par défaut, ID = 0(00), réglé sur la première caméra.
	ID = 1(10), réglé sur la seconde caméra.
	ID = 2(01), réglé sur la troisième caméra.
	ID = 3(11), réglé sur la quatrième caméra.

6.2 Réglages des dipswitches du moniteur

Il y a 6 dips au total. Les dipswitches permettent de configurer le code utilisateur de chaque moniteur.































Le dip-6 est le switch de la fin de ligne, qui doit être réglé sur ON si le moniteur est en fin de ligne (bus), sinon il doit être réglé sur OFF.

Etât	Réglage	Etât	Réglage
	Le moniteur n'est pas à la fin du BUS.		Le moniteur est à la fin du BUS.

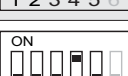
CDC-2FxB

Français

Les dips 1 à 5 servent au réglage du code utilisateur. La valeur va de 0 à 31, ce qui constitue 32 codes différents .

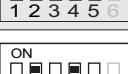
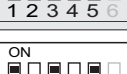
État	Code utilisateur	État	Code utilisateur	État	Code utilisateur
	Code=0		Code=11		Code=22
	Code=1		Code=12		Code=23
	Code=2		Code=13		Code=24
	Code=3		Code=14		Code=25
	Code=4		Code=15		Code=26
	Code=5		Code=16		Code=27
	Code=6		Code=17		Code=28
	Code=7		Code=18		Code=29
	Code=8		Code=19		Code=30
	Code=9		Code=20		Code=31
	Code=10		Code=21		

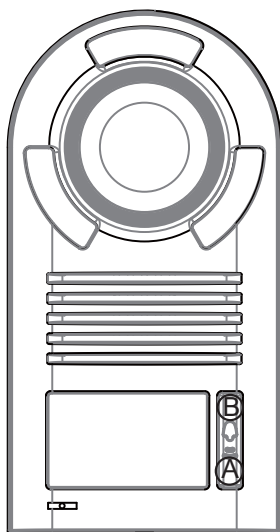

Note:

1. Si la caméra est réglée en mode 1 bouton d'appel , les moniteurs répondent aux codes utilisateurs de 0 à 15.
2. Si la caméra est réglée en mode 2 boutons d'appel, les moniteurs répondent aux codes utilisateurs de 0 à 15 pour le bouton A et de 16 à 31 pour le bouton B.

6.3 Remarques

Référence	Description	Utilisation
PS24-5	Alimentation entrée 85~260Vac, sortie 24Vdc/5A, modules 10 DIN	Pour installation avec plusieurs caméras ou plusieurs moniteurs (2 et plus)
PS24-1	Alimentation entrée 85~260Vac, sortie 24Vdc/1A, pour kit de base seulement, modules 4 DIN	Pour installation avec 1 caméra et 1 moniteur

■ 7 . Cables requis

La distance maximale de câblage est limitée. L'utilisation de différents câbles peut jouer sur la distance maximale que le système peut atteindre.

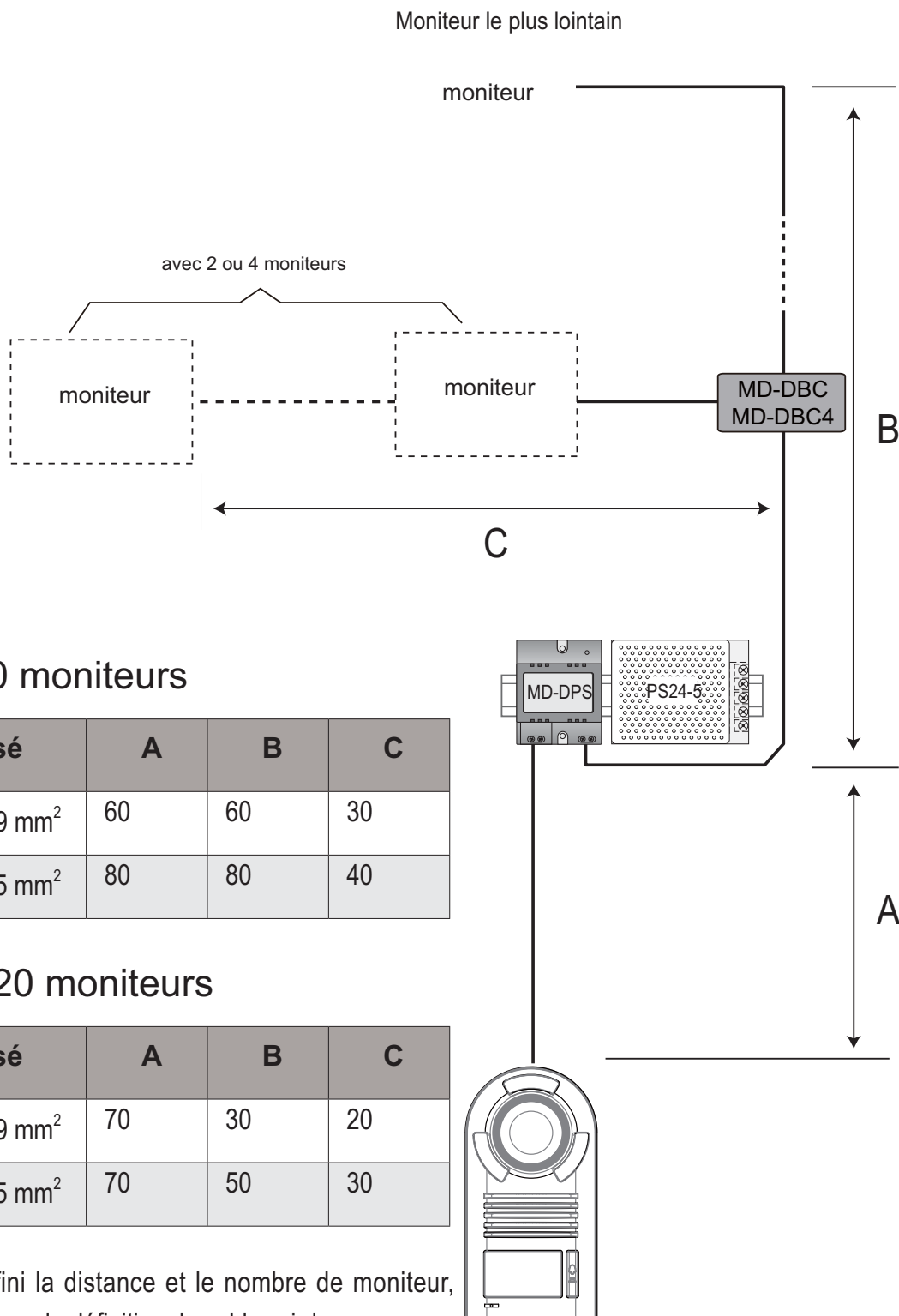

Inférieur à 20 moniteurs

Câble utilisé	A	B	C
Câble croisé 2 x 0.9 mm ²	60	60	30
Câble croisé 2 x 1,5 mm ²	80	80	40

Supérieur à 20 moniteurs

Câble utilisé	A	B	C
Câble croisé 2 x 0,9 mm ²	70	30	20
Câble croisé 2 x 1.5 mm ²	70	50	30

Note:Après avoir défini la distance et le nombre de moniteur, reportez vous au tableau de définition de cables ci-dessus.

■ Regulation - Règlementation

The video door entry system door stations reference CDC-2F1B and CDC-2F2B have been submitted to a serie of tests by SEM Test Compliance Service Co, Ltd and has been declared in total accordance to the directives CE 2004/108/EC et 2006/95/EC.

Les modèles de caméra vidéo-portier références CDC-2F1B et CDC-2F2B ont été soumis à une série de tests par la société SEM Test Compliance Service Co, Ltd et ont été déclarés conformes aux Directives CE 2004/108/EC et 2006/95/EC.

Rapport n° : STR10058262E-1, STR10058262E-2 et STR10058262S

Standards test : EN 55022 : 2006+A1 : 2007

EN 55024 : 1998+A1 : 2001+A2 : 2003

EN61000-3-2 : 2006+A2 : 2009

EN61000-3-3 : 2008

EN 60950-1 : 2006+A11 : 2009

The test report shows that the product is in total respect to the required and tested standards.

Le rapport des essais mentionné montre que le produit est conforme aux exigences des standards testés.

Le design et les caractéristiques techniques peuvent être modifiés sans notification. Les droits d'utilisation de ce manuel sont protégés.



PROEM
1140, rue André Ampère - Acti'indus
13851 Aix en Provence Cedex 3 - France

☎ +33 4 42 96 58 73
☎ +33 4 42 96 45 77

info@proem.fr
www.proem.fr